

Mercedes 240 & 290 GD in Hellenic Service Set 2

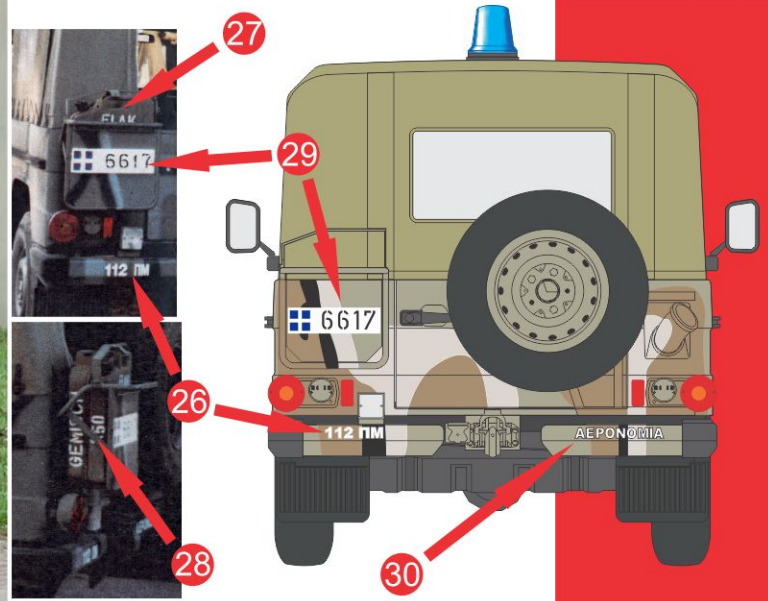

Hellenic Air Force Mercedes 240 are finished in the same 4 colour MERDC type camouflage as army vehicles. When they are repainted variations can appear in both the colour tones and the camouflage pattern. This vehicle was in service with the air force police detachment of the 112 Combat Wing. Some interesting, but unfortunately not completely visible, markings were carried on the jerrycan.



The vehicles serving with peace keeping forces abroad often have protective wire mesh fitted over the windows. The windscreen mesh has two sections, the one on the driver's side can be slid sideways to improve visibility when its protection is not needed. Most vehicles also had a

MG mounting for an MG3 machine gun fitted to the vehicle's roll-bar. The tarpaulin had had a opening section through which the gunner could stand to operate the weapon.

Orange air recognition panels were fixed on the roof.

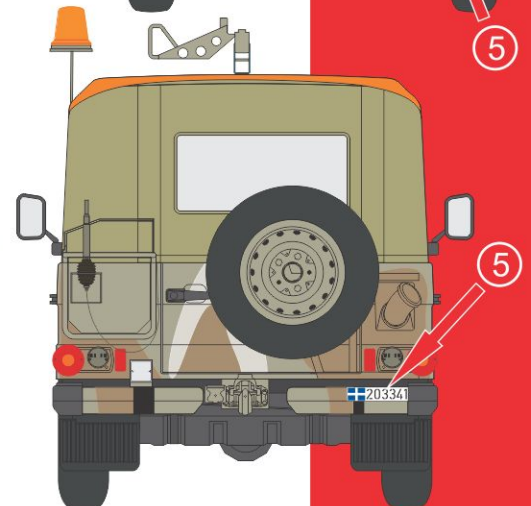
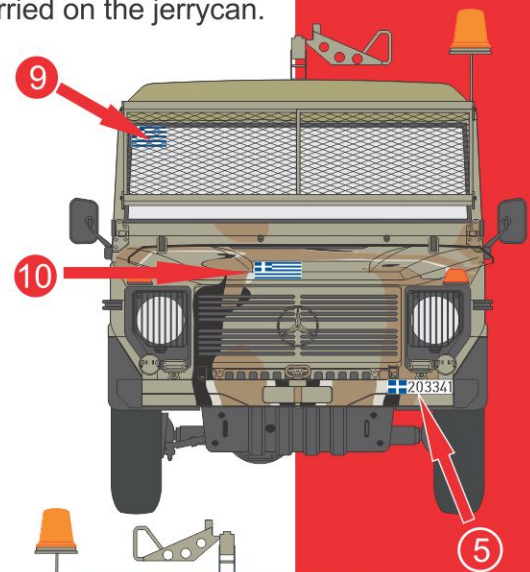

Mercedes 290GD, 32nd Marine Brig. Athens 25 March



Both the tire pressure markings and the number plates were on metal plates fixed with screws.

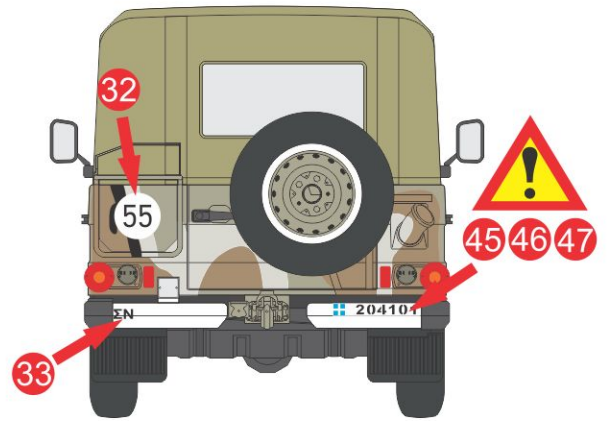

Military police vehicles always have a white trim. This is applied to the bumpers, front and rear, the front of the bonnet, the lower windscreen frame, above the waistline on the sides and to the tire rims.

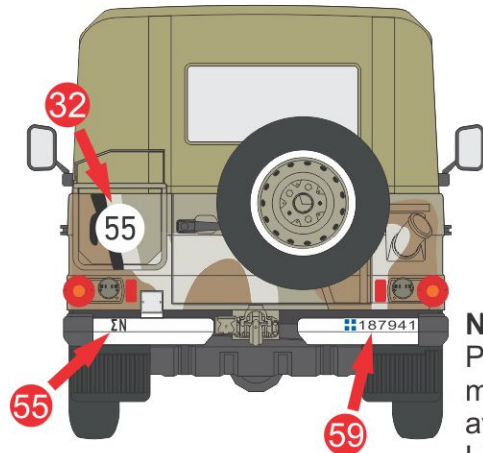

Note: Military Police helmet markings are available in set LM35009.

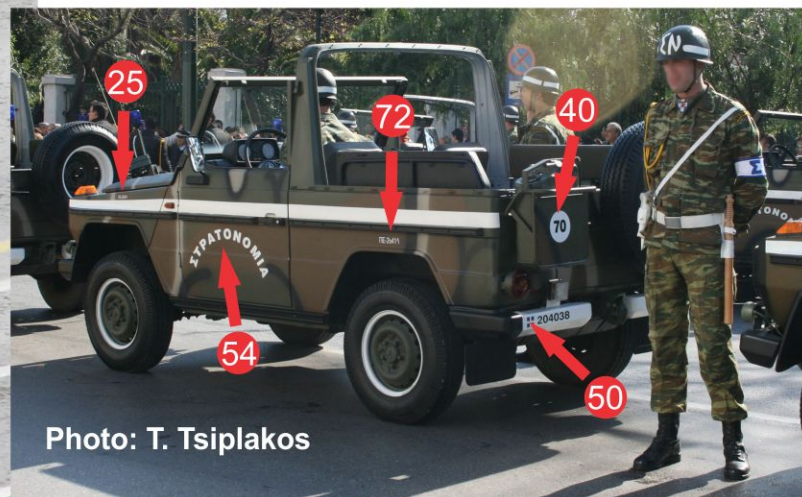

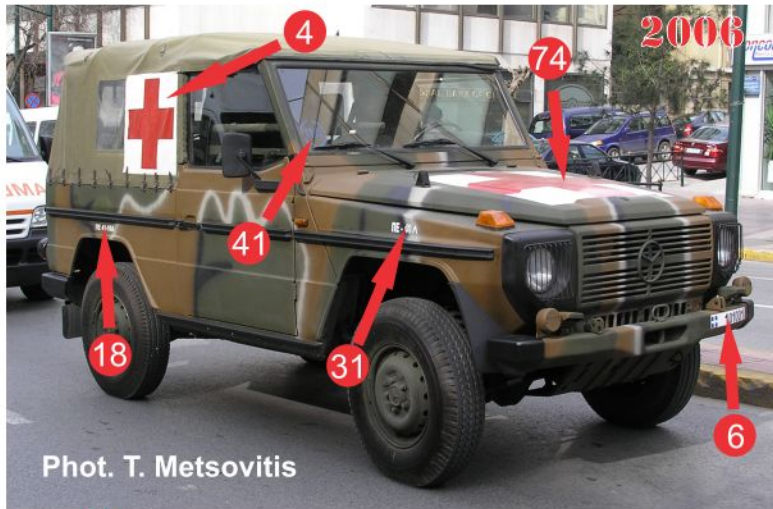

Phot. T. Metsovitis



Phot. T. Metsovitis



This vehicle was a regular participant in the Independence Day parade in Athens and over the years changed slightly in appearance as it was repainted and also got another tilt.



Phot. T. Metsovitis



Phot. T. Metsovitis



Phot. T. Metsovitis

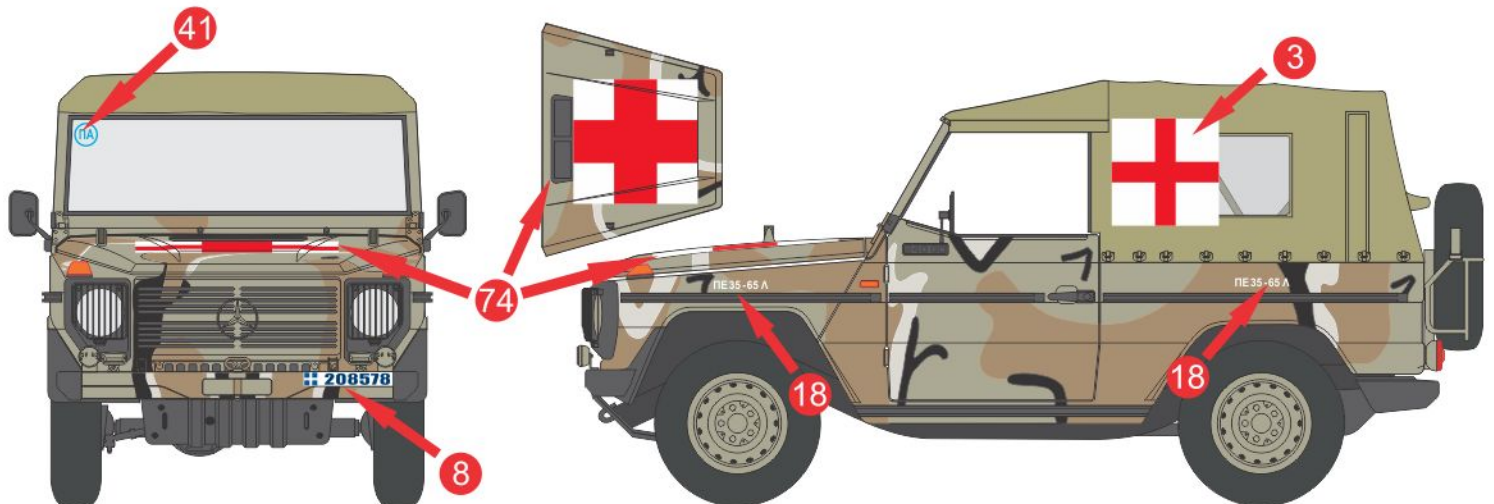
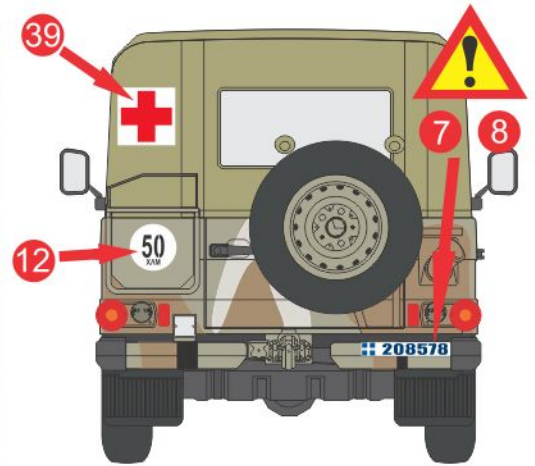

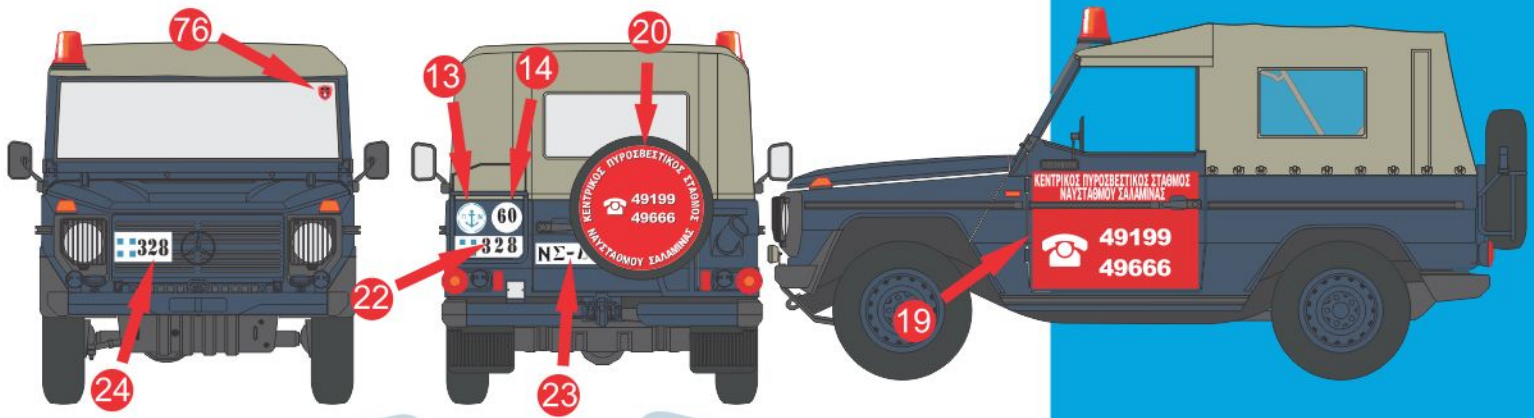

Navy Police 25th March 1994

Salamina Naval Base central fire station 2009

Hellenic Navy 2013.

Both the front number plate **68** and the naval insignia **70** were metal plates fixed to the radiator grill.

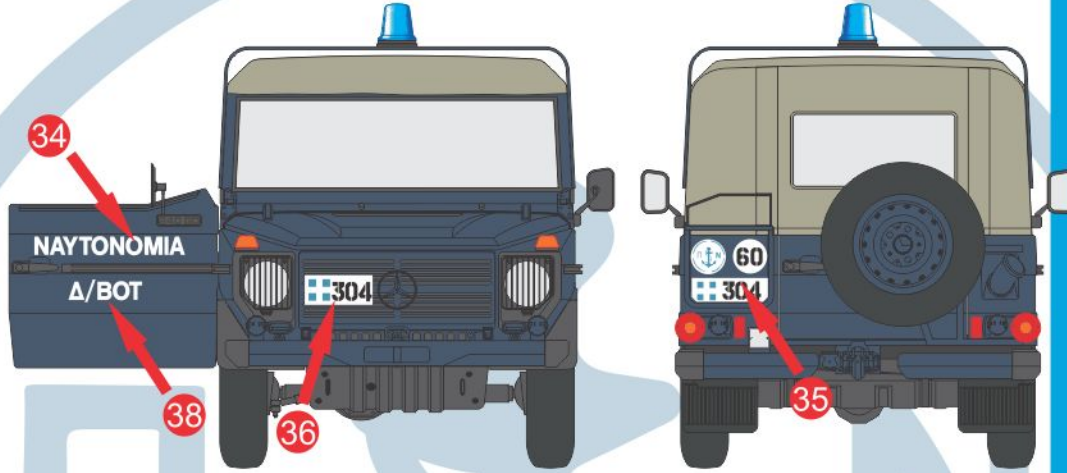

Naval Installation Guards 2013.

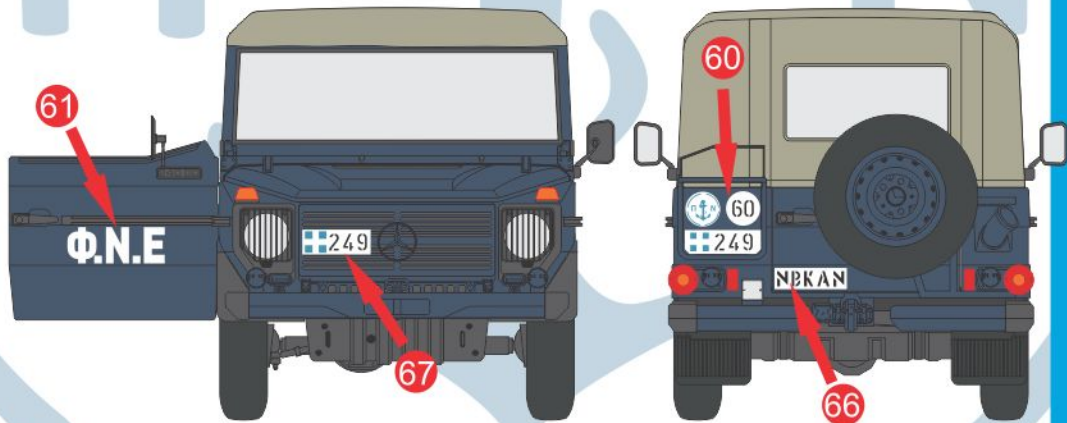
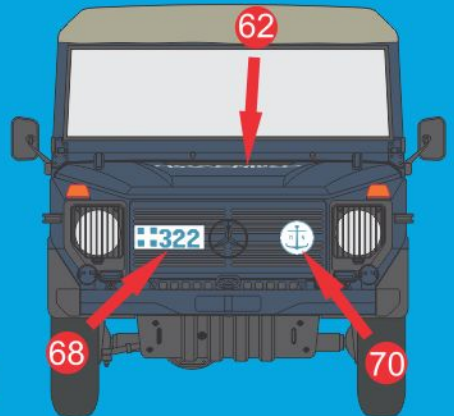

NOTE: The Navy Police logo may not have always been present on the vehicle's doors.

Navy Police 25th March 2009

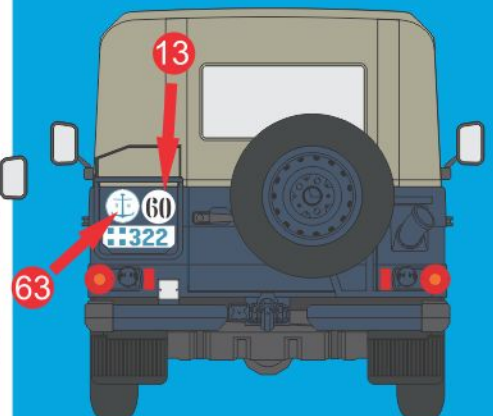
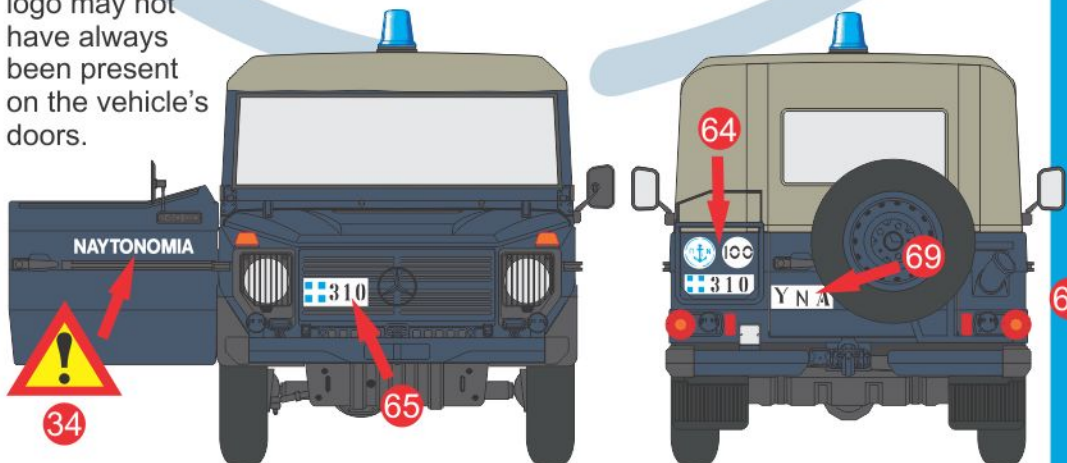

Mercedes 240 & 290 GD in Hellenic Service Set 2

LM35017



ATTENTION!

This symbol indicates that alternative markings are applicable in this position **OR** that the same marking is applicable to more than one colour scheme.

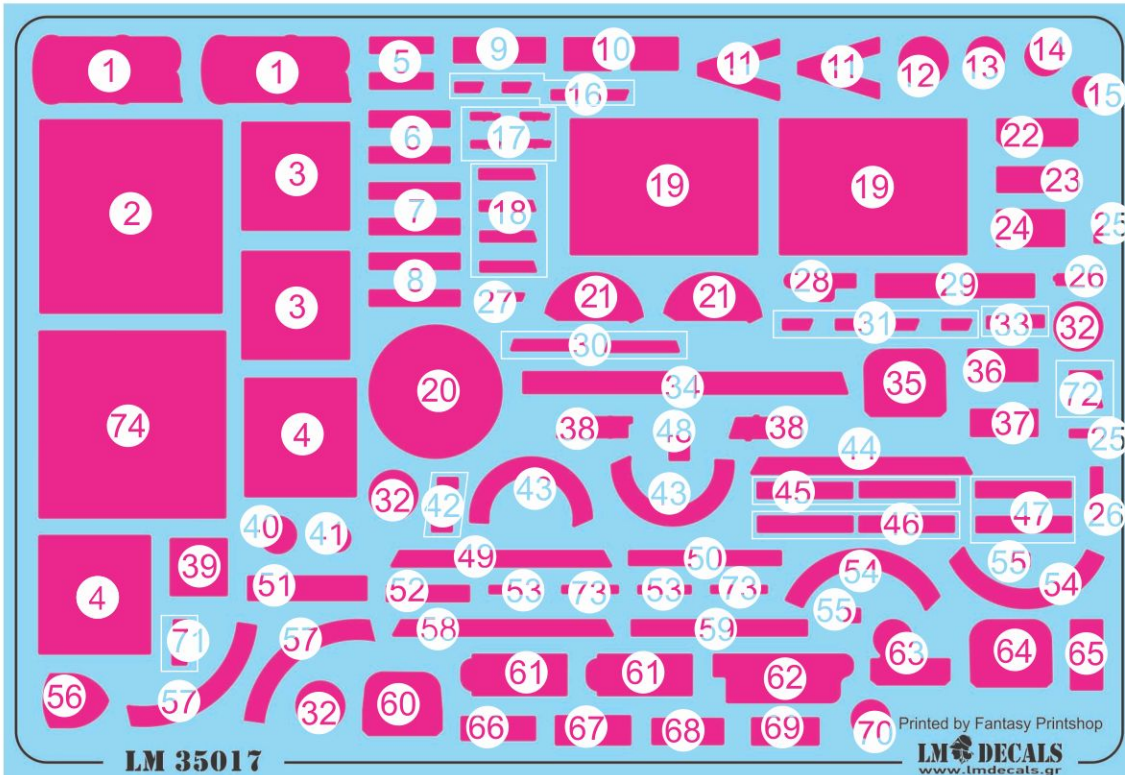

NOTE

The markings below have been printed on a digital Sol-Ink printer by DecalPrint.de. The modeller should treat these with extra care and cut as close as possible to the design because the carrier film extends over the complete decal paper.

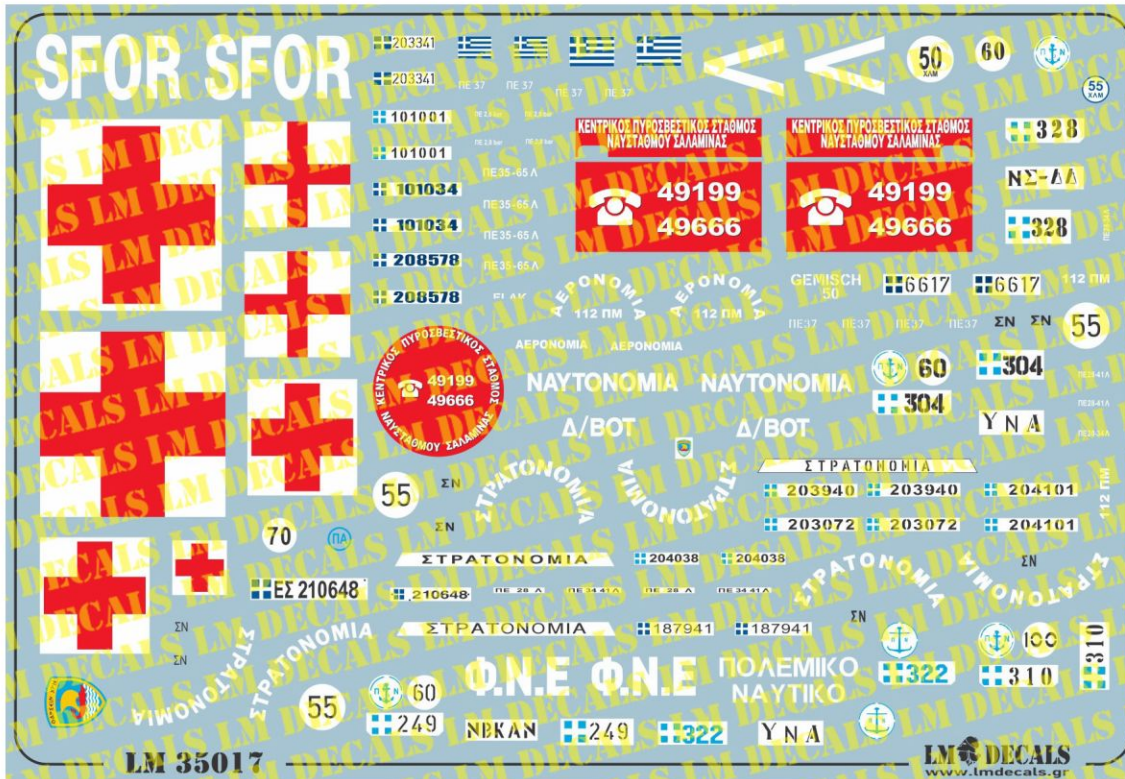

Photo: T. Metsovitis

Early examples of the Mercedes 240 in Greek service carried the ELVO logo on the rear door to indicate their Greek manufacture.